

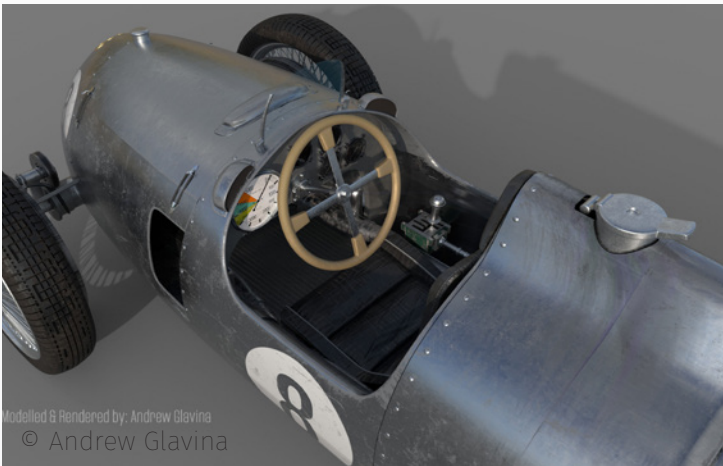

3d Modelled & Rendered by: Andrew Glavina

© Andrew Glavina



Modelled & Rendered by: Andrew Glavina
© Andrew Glavina



3d Modelled & Rendered by: Andrew Glavina
© Andrew Glavina



© Andrew Glavina

3d Modelled & Rendered by: Andrew Glavina



3d Modelled & Rendered by: Andrew Glavina
© Andrew Glavina

1936 Auto Union Type C ~ 16 Cylinders, Top Speed 270 mph



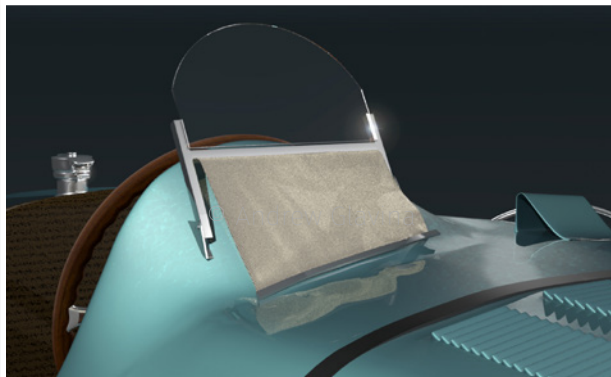

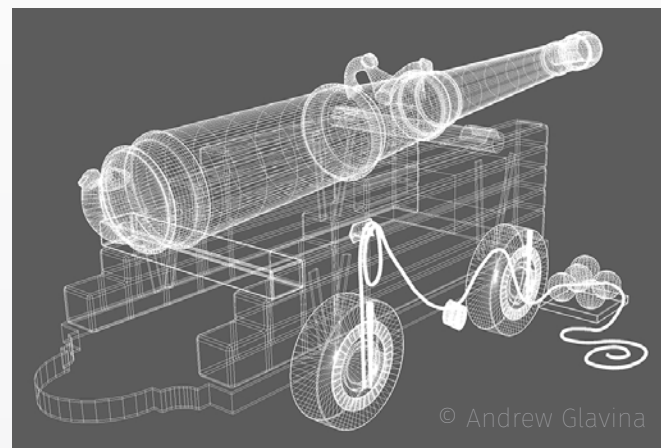
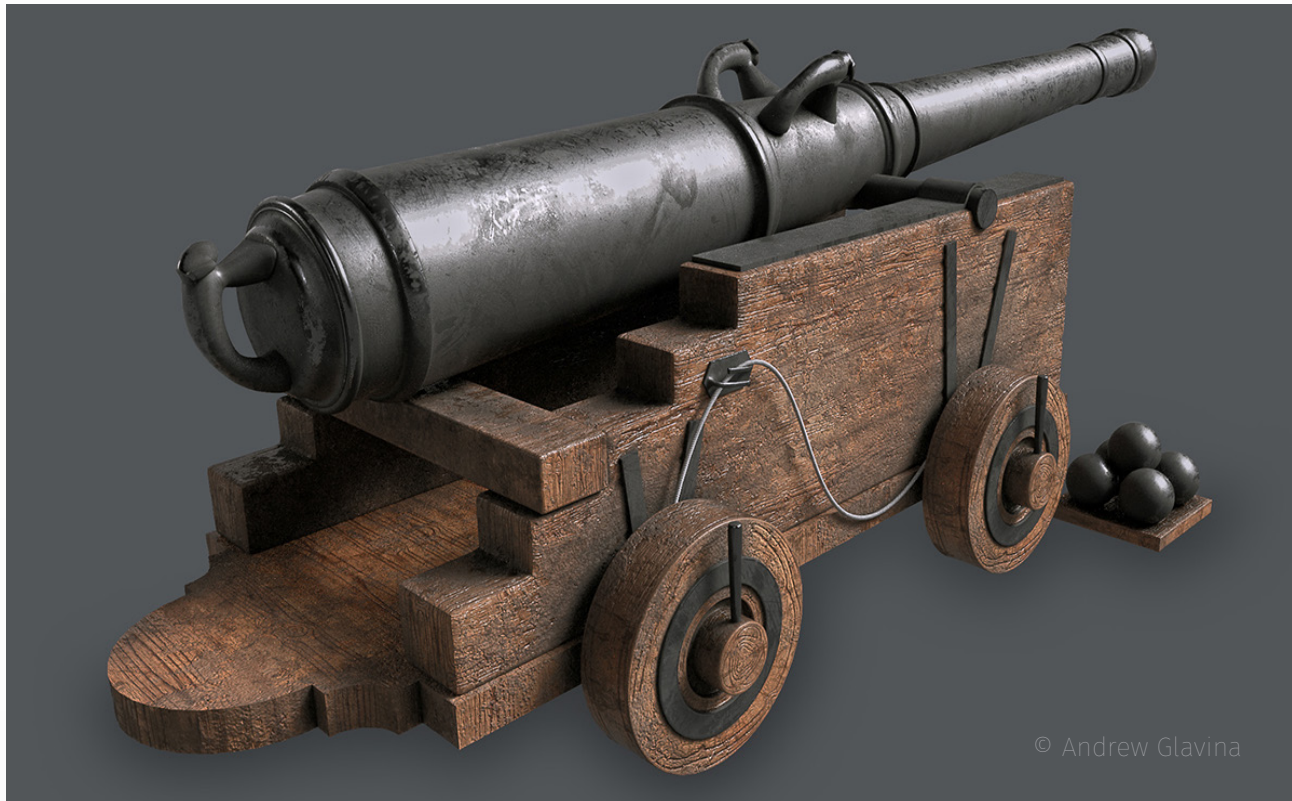

3D Model & Wireframe Render - Vasa Cannon



3D Model & Render

Silverton



3D Model & Render

Silverton

© Andrew Glavina
3D Modelling & Rendering By: Andrew Glavina



3D Model & Render

Custom MotorcycleDesign



3D Model & Render

Custom Motorcycle Design



3D Model & Render

Custom MotorcycleDesign

© Andrew Glavina



3D Model & Render

Custom Motorcycle Design

© Andrew Glavina

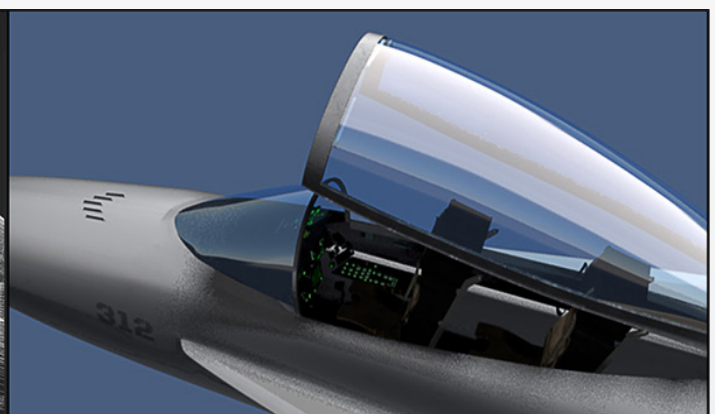
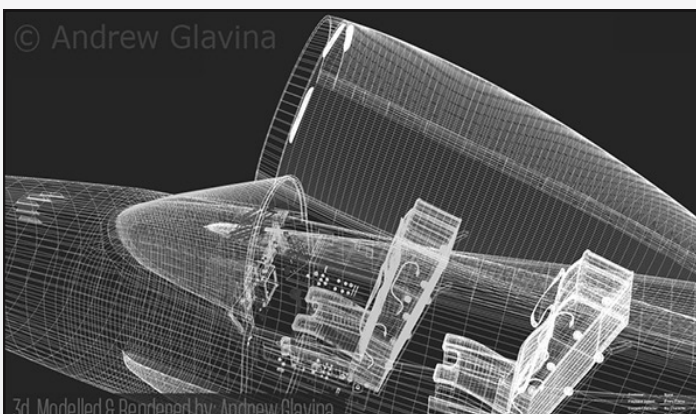
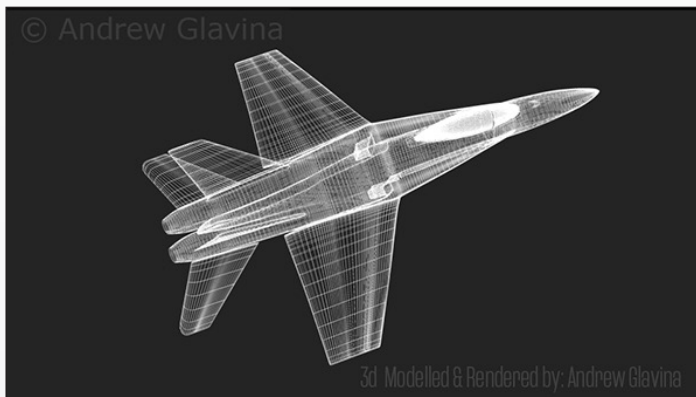



ANDREW GLAVINA DESIGNER

3D Modelling & Illustration
F4U Super Hornet

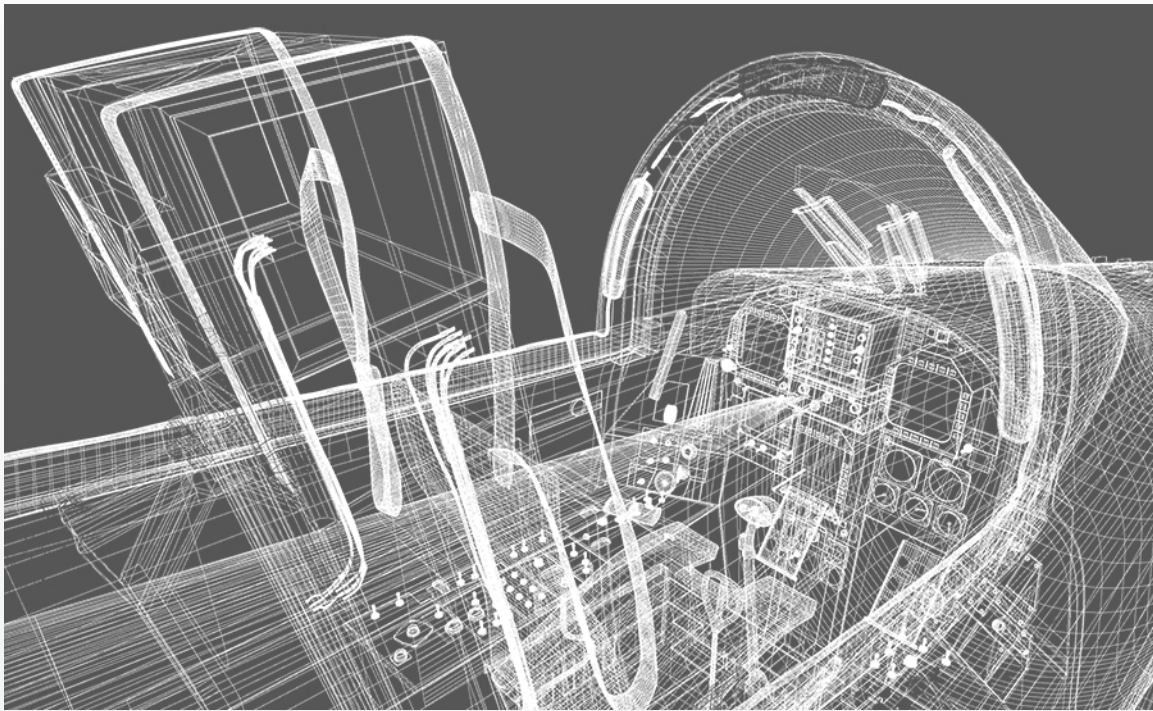
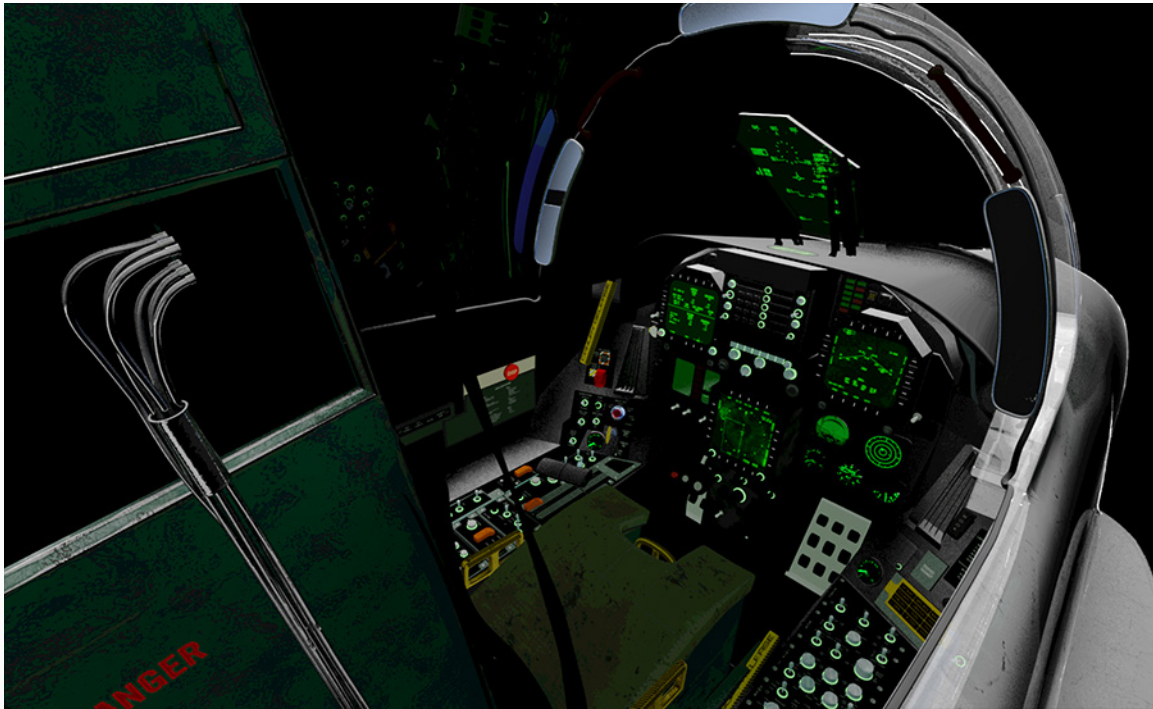



© Andrew Glavina



© Andrew Glavina



© Andrew Glavina

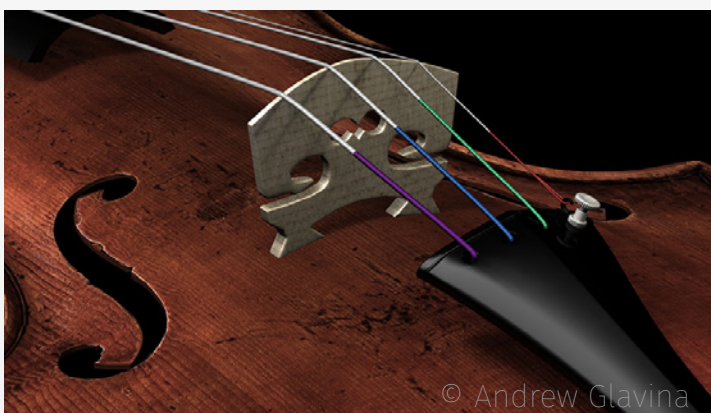

© Andrew Glavina



© Andrew Glavina

3D Model & Render - Stradavarius Violin

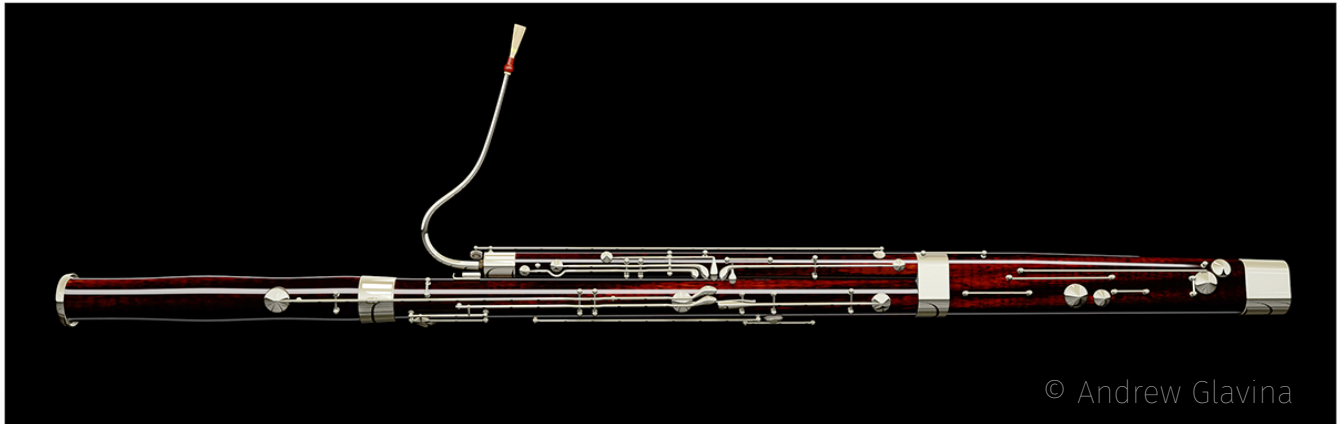

3D Model & Render - Bassoon